

Progress Report on GEMS GRG

Guy Brasseur and Martin Schultz



Sub project structure

WP1: Assimilation of gas-phase chemical species in the stratosphere and troposphere

leader: H. Eskes

WP2: Implementation of global CTMs in the ECMWF system

leaders: G. Brasseur, M. Schultz

WP3: Development of prototype user services

leader: A. Arola

WP4: Evaluation of reanalysis simulations

leaders: J.P. Cammas, K. Law



Data Flow and Responsibilities in GEMS GRG

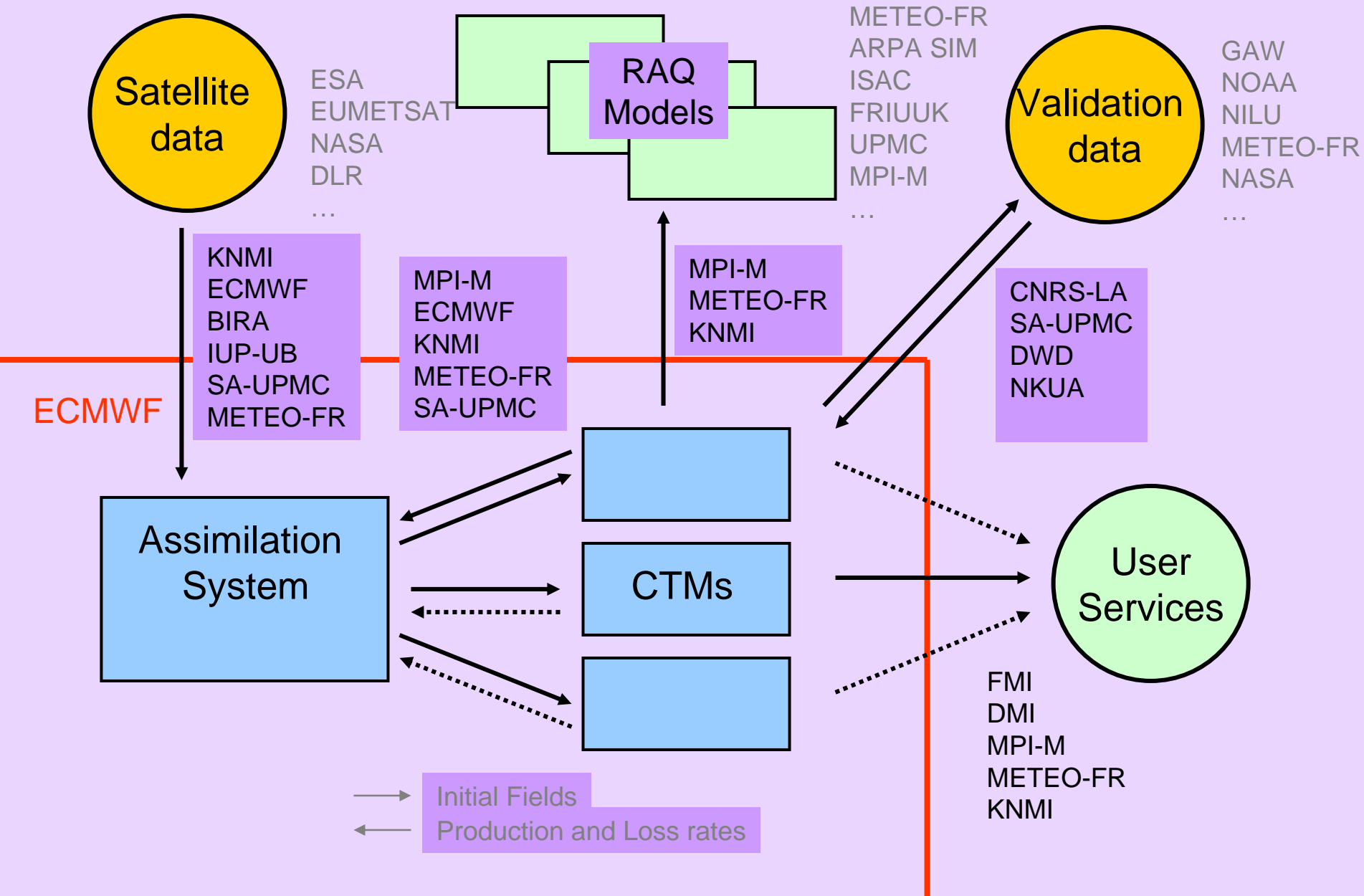

WP1: Assimilation

- IFS model has been extended to accommodate GRG tracers
- Definition of chemical production and loss rates to be transferred from CTMs to IFS
- Introduction of P&L to IFS pending successful testing of OASIS 4 interfaces
- Sciamachy data sets for ozone and NO₂ provided by KNMI, awaiting reformatting and assimilation tests



WP2: CTM Implementation

- 3 CTMs installed at ECMWF computer system
- Parallelisation/Performance issues addressed
- Workshop on CTM-IFS coupling strategy (Oct. 2005)
- Discussions on exchange of chemical production and loss rates
- Implementation of OASIS 4 and toy model development
- Preparation for year-2003 forward simulations (including “ERA-2003” (PRO) and emission data sets)
- Work on CTM-IFS interfaces started (reading of met. fields and assimilated chemical fields, output of P&L)

The logo for GEMS (Global Earth Modelling System) features the word "GEMS" in large, white, sans-serif capital letters. The letters are set against a background of a grid pattern. To the left of the text, there is a circular graphic element containing a stylized globe or a similar abstract design.

Chemical data assimilation strategy

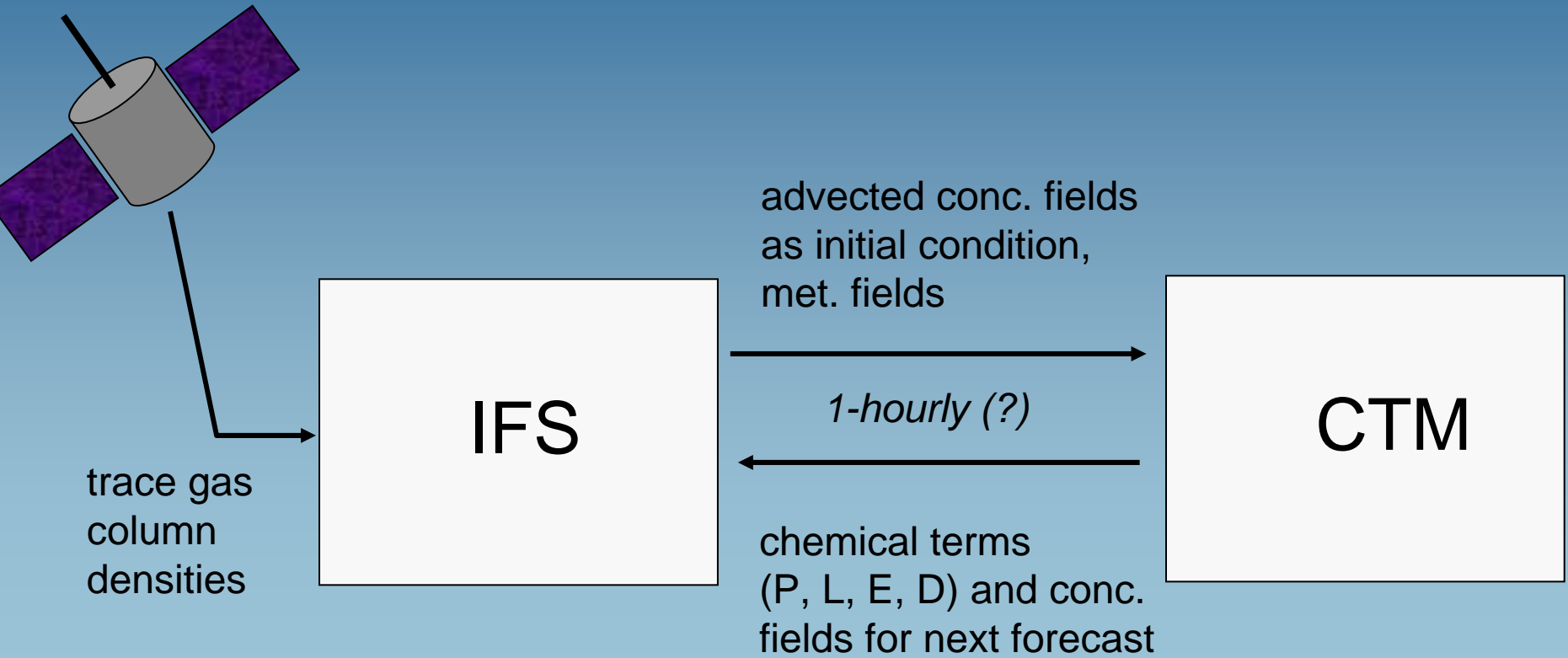

CTM equation

Mass budget for each species

Number of species $i = 1 \dots 100$

$$\frac{\partial c_i}{\partial t} + \mathbf{V}_h \cdot \nabla_h c_i + \frac{\partial}{\partial z} w_c c_i - \frac{\partial}{\partial z} K_z \frac{\partial c_i}{\partial z} = E + R - D$$

$E_i \neq f(c_i)$... Emission

$R_i = f(c_i, c_j, c_k, c_m, \dots)$... Chemical conversion

$D_i = l_{Dep} c_i$... Deposition

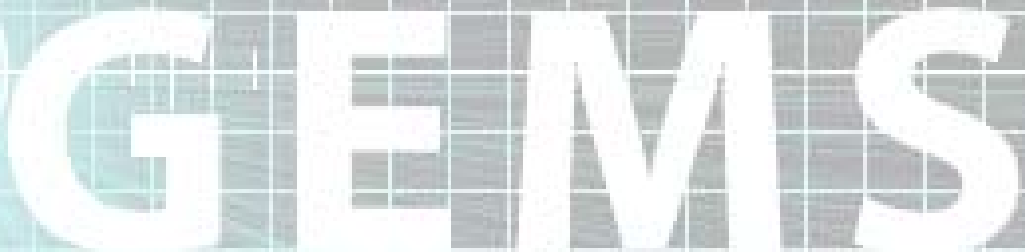
The logo for GEMS (Global Earth Modelling System) features a stylized globe on the left, overlaid with a grid pattern. To the right of the globe, the word "GEMS" is written in large, bold, white capital letters. The background of the slide is a blue gradient with a grid pattern.

500 hPa MOZART

P(O₃)
MOZART

03_PROD_inst [/CM3/S], 08Jan2003 00:00, ca. 495.870 hPa

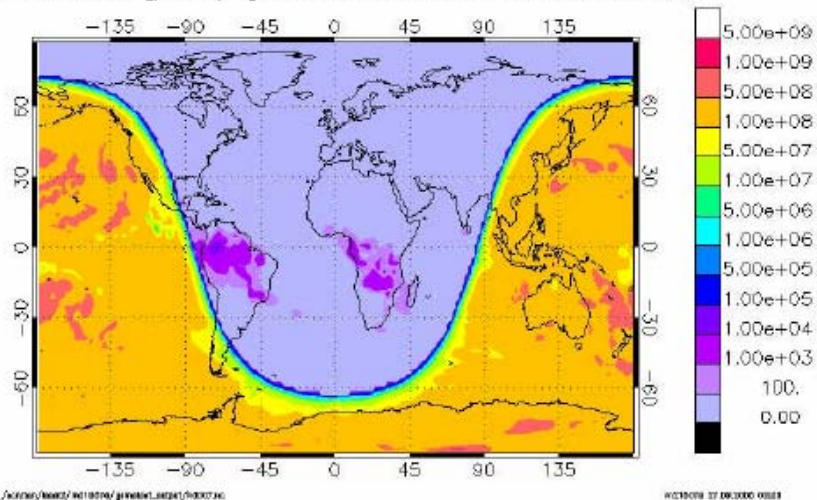

Watch the gradients!

L(O₃)
MOZART

03_LOSS_inst [/CM3/S], 08Jan2003 00:00, ca. 495.870 hPa

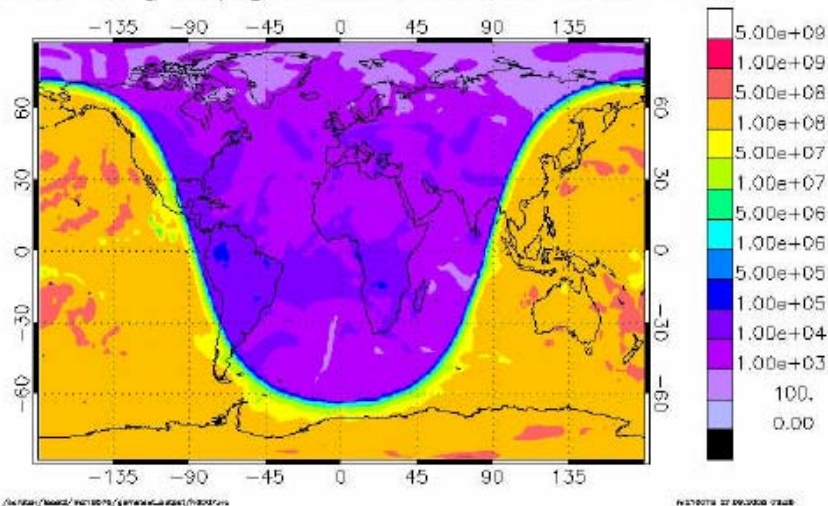

1.12.2005

O. Stein (MPI-M)

WP3: Prototype user services

- Strategy for calculation of UV exposure developed (focus on clouds and surface albedo)
- Discussions on storage of CTM output (to be continued today and tomorrow)
- Questionnaire to RAQ



WP4: Evaluation

- Survey of available data sets (ongoing)
- Discussions with data providers – both for reanalysis purpose and near-realtime transfer
- Data transfer and (some) analysis tools installed and tested
- Definition of CTM output formats and fields
- Two workshops on evaluation January 2006



Data set survey

	A	B	C	D	E	F
1						
2	Available data sets GRG					
3						
4	Source	Parameters	Contact for data base	Email of data base contact	Web site	Availability
5	Ground based (station) data					
6						
7	WMO/GAW global stations	CO, NO _x , VOC, SO ₂ , Precip. Chemistry				
8	WMO/GAW World Data Centre for Greenhouse Gases (WDCGG)	O ₃ (ground), CO, NO _x , VOC,...	Japan Meteorological Agency, 1-3-4, Otemachi, Chiyoda-ku, Tokyo 100-8122, Japan, Tel: +81-3-3287-3439, Fax: +81-3-3211-4640	wcgg@hq.kishou.go.jp	http://gaw.kishou.go.jp/wdogg.html	Made available to GEMS by the Global Atmospheric Watch (GAW) network
9	WMO/GAW regional stations	CO, CH ₄ , aerosol chemistry, BC, meteorolog. Parameters, O ₃ column and surface, solar radiation (visible and UV)				
10	WMO/GAW World Ozone and Ultraviolet Radiation Data Centre (WOUDC)	lists are available for GEMS contact, discussion needed. O ₃ column and profile, UV solar radiation	Meteorological Service of Canada, 4905 Dufferin Street, Toronto, Ontario, CANADA, M3H 5T4, Phone: +1-416-739-4635 Fax: +1-416-739-4281	woudc@ec.gc.ca	http://www.woudc.org/find_ex_e.html	Made available to GEMS by the Global Atmospheric Watch (GAW) network
11	CMDL	O ₃ , CO, NO _x , etc			http://www.cmdl.noaa.gov	
12	selected supersites (e.g. Hohenpeissenberg)	O ₃ , NO _x , PAN, CO, VOC, peroxides, OH, etc	Harald Berresheim	Harald.Berresheim@dwd.de	http://www.dwd.de/dfu/ndE/Obsvator/MDHP	Hohenpeissenberg data available



Reg1 (E. US)

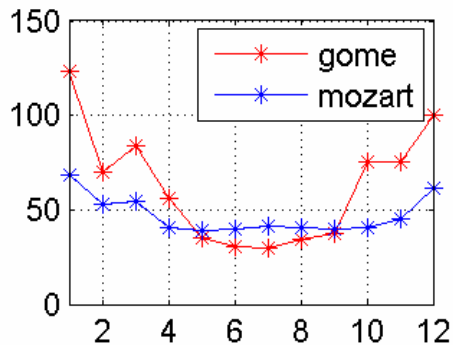

Reg2 (whole US)

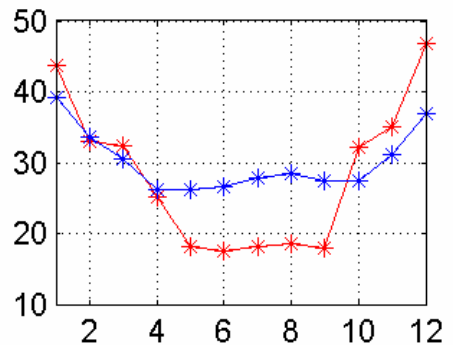

Reg3 (E. Europe)

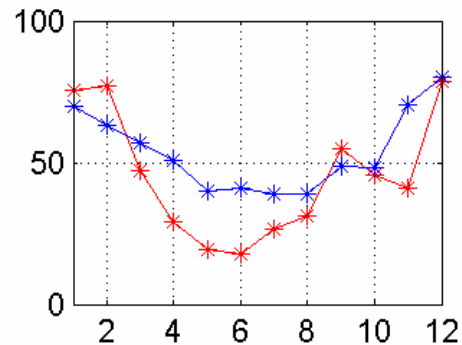

Reg4 (S. China)

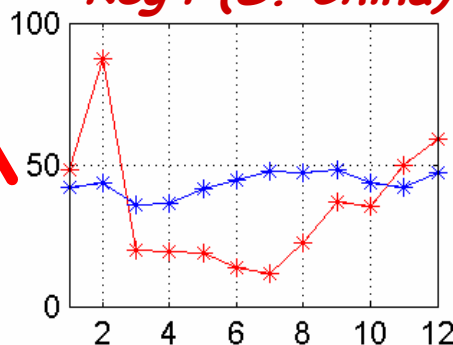

Reg5 (NE. China)

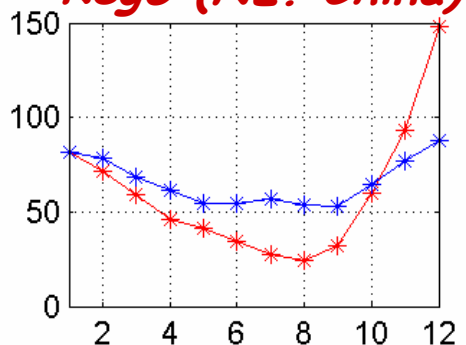

Reg6 (W. Europe)

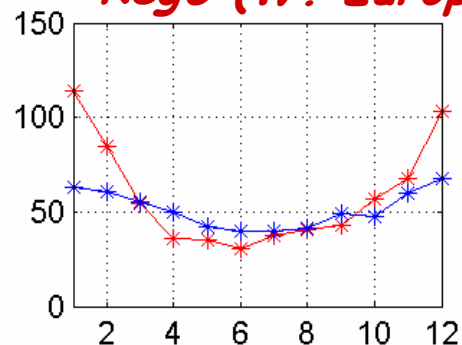

Reg7 (Japan)

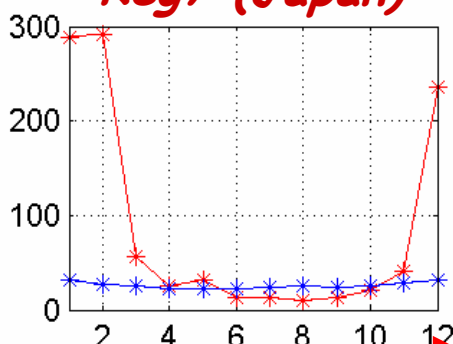

Reg8 (Atlantic Oc.)

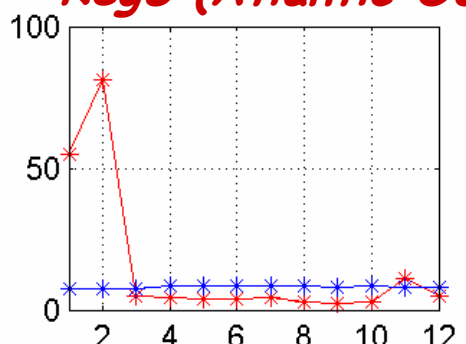

tropospheric column (10¹⁴)

month

**Validation:
Comparisons between
MOZART and GOME NO2**

July

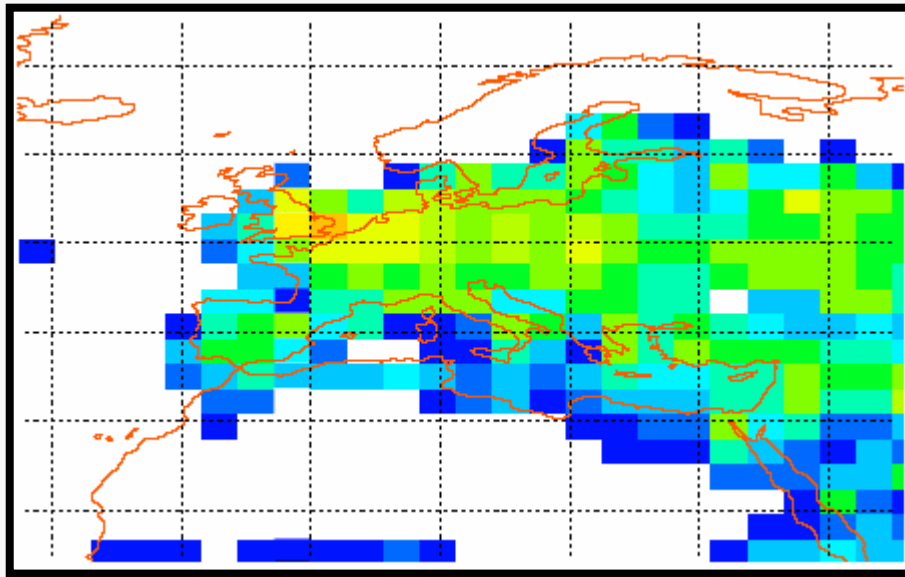

MOZART

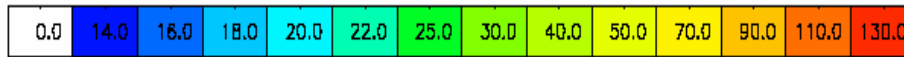

(10^{+14} molec/cm²)

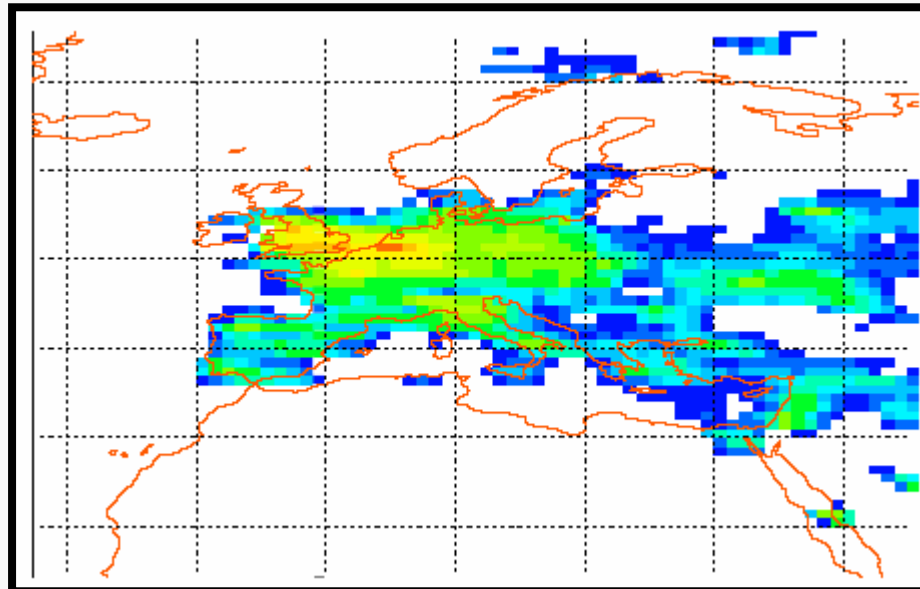

GOME

GEMS presentations

(to be completed)

- NDSC ozone working group meeting, HP, Sep. 2005
 - GAW/ACCENT workshop on CO, Dübendorf, Oct. 2005
 - HTAP meeting, Washington, Jan. 2006
- + communications with data providers...

upcoming:

- EGS, Vienna, Apr. 2006
- WMO/ACCENT expert workshop, Geneva, Apr. 2006



GRG breakout sessions

Tuesday afternoon:

- Review of activities
- CTM coupling / available data sets for evaluation

Wednesday morning:

- Use of observational data
- Data transfer/formatting issues

Wednesday afternoon:

- Work plan months 13-30



Data Flow and Tasks in GEMS_GRG_1

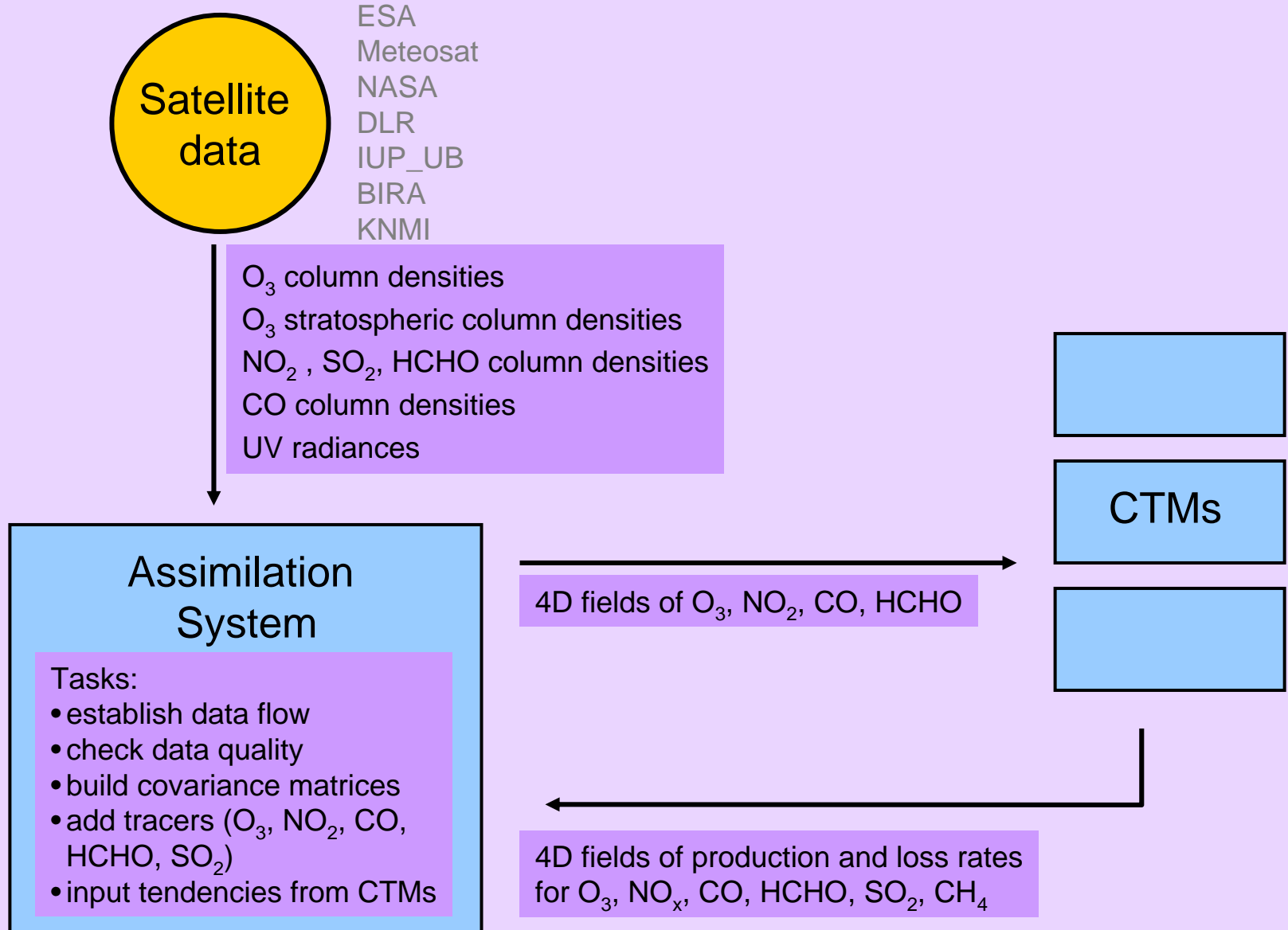

Data Flow and Tasks in GEMS_GRG_2

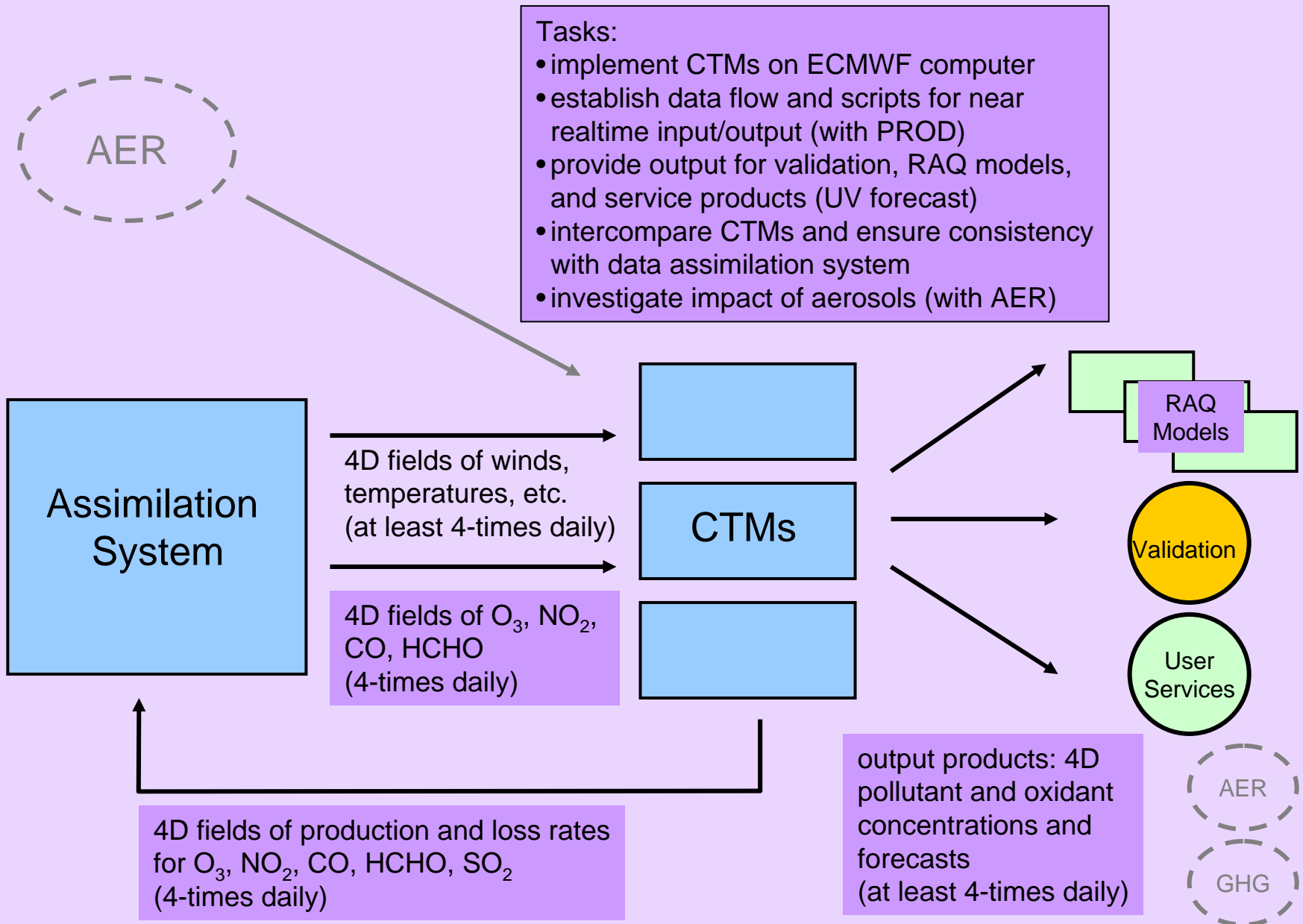

Data Flow and Tasks in GEMS_GRG_3

Tasks:

- consult with users to define products and product specifications
- develop realtime UV forecast product
- implement suitable diagnostics and data streams for background pollutant concentrations and doses, and deposition and emission fluxes
- make products available on the web

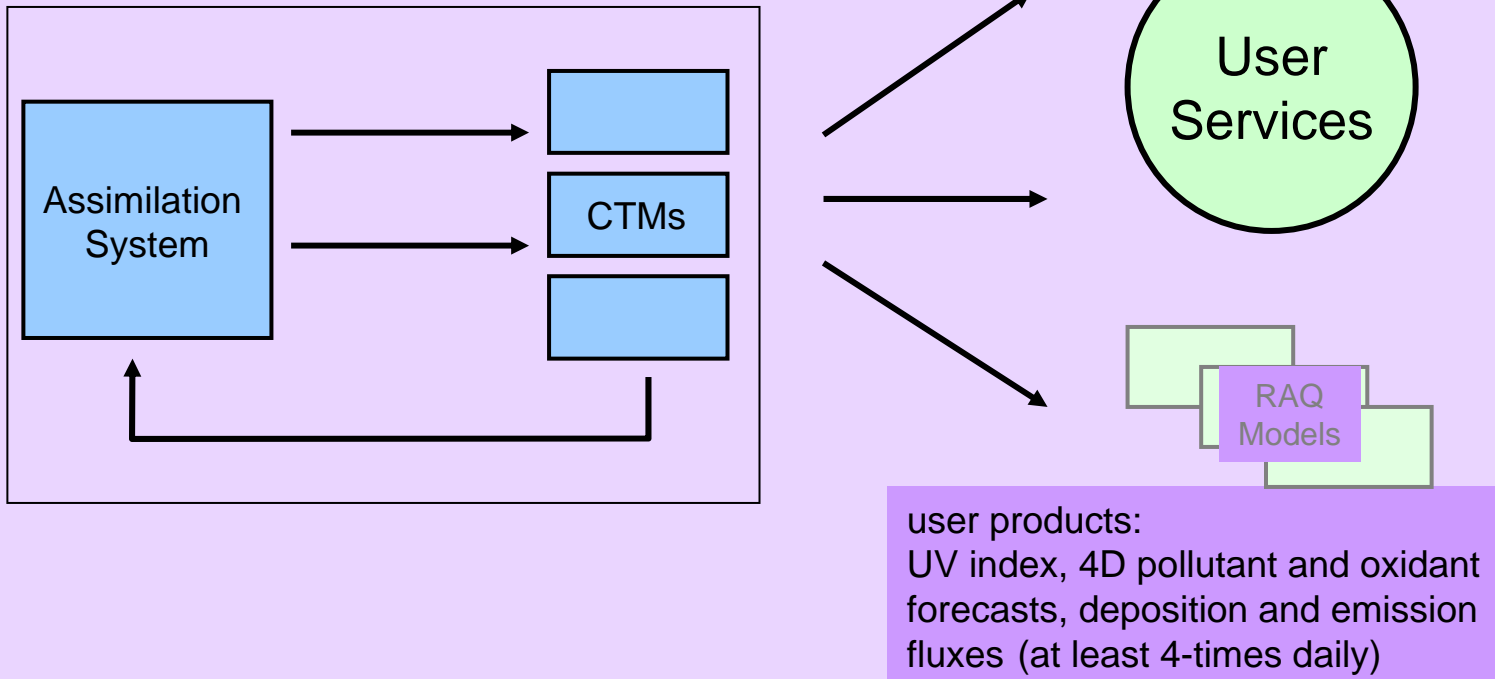

Data Flow and Tasks in GEMS_GRG_4

Tasks:

- define data formats and data exchange protocols for validation data and model output
- compile available data sets
- develop validation procedures (daily/monthly, case studies) and define parameters
- evaluation of reanalysis run
- define future validation procedure for post-GEMS system

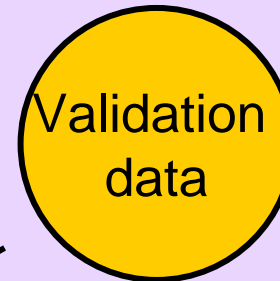
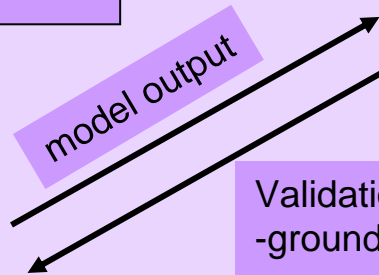
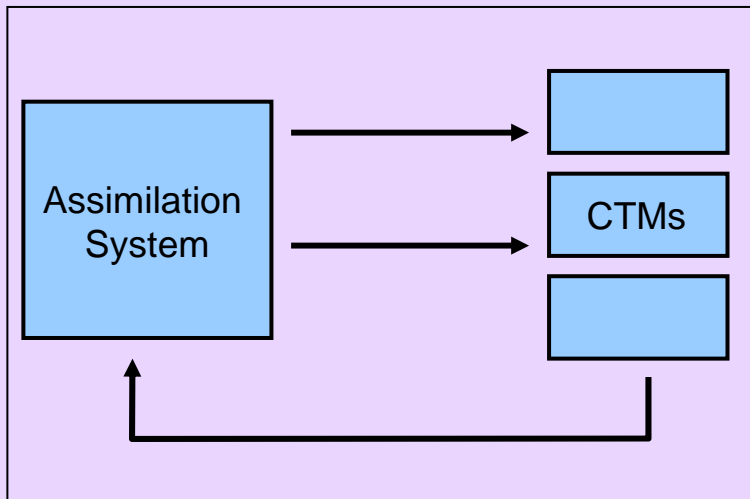

Validation data:

- ground based station data
- ozone sondes
- DOAS and lidar obs.
- aircraft profiles and flight tracks
- research satellite products

Work plan months 13-30

- consolidation of the GEMS system
- finish implementation of OASIS 4 interfaces
- perform and evaluate first 2003 reanalysis runs
- link CTMs to data assimilation
- assess scientific issues related to IFS-CTM coupling (“dislocation problem”)
- sensitivity studies (daily cycle of emissions etc.)
- develop evaluation tools
- finalize interfaces with RAQ, develop interfaces with AER and GHG
- develop first prototype user services
- prepare longer reanalysis simulations (2000-2006)

The logo for GEMS (Global Earth Modelling System) features the word "GEMS" in large, white, bold, sans-serif capital letters. The letters are set against a background of a grid pattern. To the left of the text, there is a stylized globe showing the Earth's continents and oceans, with a white grid overlaying it. The entire logo is positioned in the bottom right corner of the slide.

GEMS